

# FFP LC & SC in 2 & 3 mm

## Montageanleitung / Mounting Instructions



Gefahr von Augenschäden.  
Wir empfehlen, eine Schutzbrille zu tragen.  
*Risk of eye damage.  
We recommend wearing safety goggles.*



Gefahr von Augenschäden.  
Schauen Sie nicht direkt in einen Laser, Faserende, Stecker oder Kupplung.  
*Risk of eye damage.  
Do not look directly into a laser, fiber end, connector or adaptor.*

### Komponenten / Components

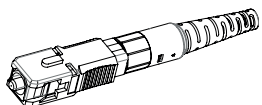

Stecker / Connector SC

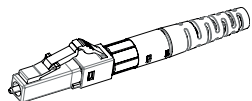

Stecker / Connector LC

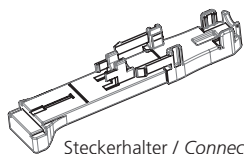

Steckerhalter / Connector holder

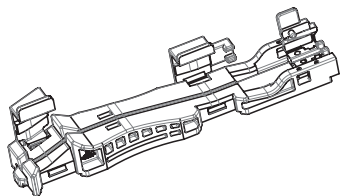

Faserhalter für / Fiber holder for 900 µm

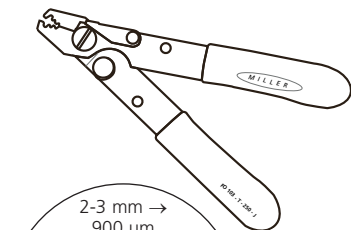

Absetzlinge / Stripping tool

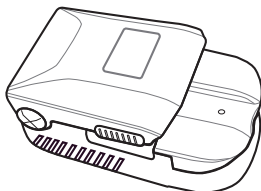
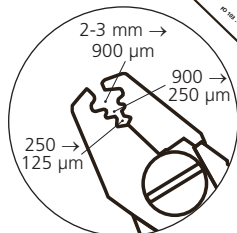

Faser Cleaver / Fiber Cleaver

1 Überziehen der einzelnen Komponenten in numerischer Reihenfolge über das Kabel  
*Pull the individual components over the cable in numerical order*

4 Pre-kevlar stopper    3 Kevlar stopper    2 Schlauch / Tube    1 Tülle / boot

Abmanteln des Kabels mit Absetzlinge / Removing outer sheaths and buffer with stripping tool

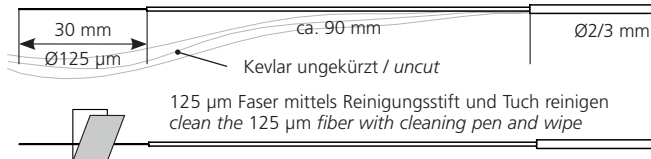

2 900 µm Faser in den Faserhalter einsetzen und Klammern (1, 2 und 3) schließen / Insert the 900 µm fiber into the fiber holder and close the covers (1, 2 and 3)

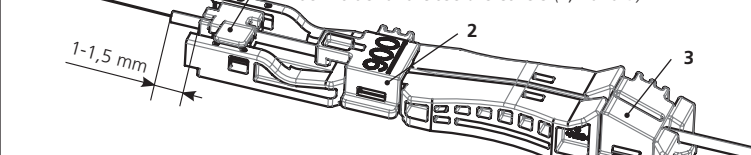

3 Faserhalter in Cleaver einsetzen und blanke Faser auf 9-11 mm kürzen  
*Set the fiber holder onto the cleaver and shorten the bare fiber to 9-11 mm*

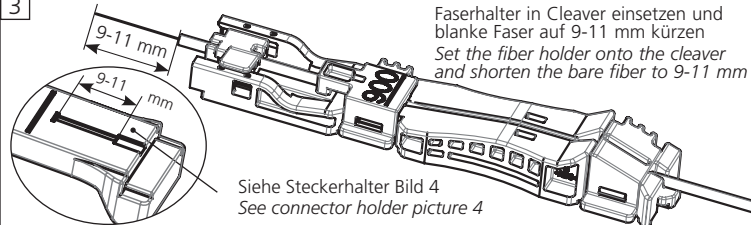

Siehe Steckerhalter Bild 4  
*See connector holder picture 4*

4 Faserhalter in die Führungsschiene des Steckerhalters einsetzen und bis zum Anschlag verschieben / Set the fiber holder to the guide rail of the connector holder and slide until it stops

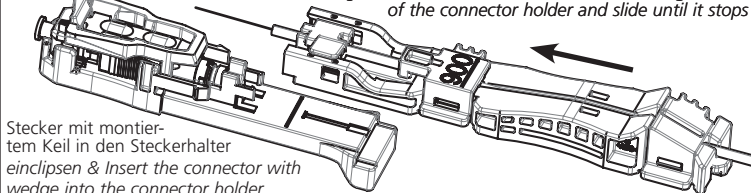

Stecker mit montiertem Keil in den Steckerhalter einclippen & Insert the connector with wedge into the connector holder

5 Klammer 2 öffnen und Faserhalter verschieben bis Clickgeräusch ertönt

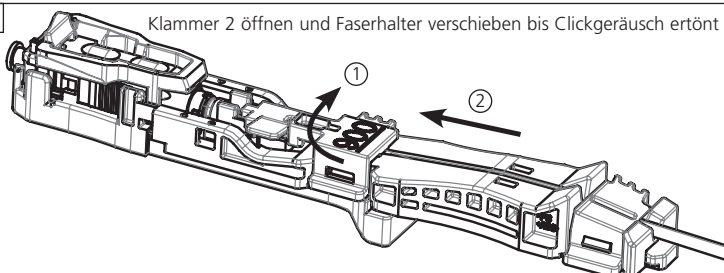

6a Hebel öffnen

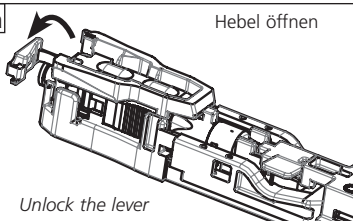

Unlock the lever

6b Drücken und Keil entfernen

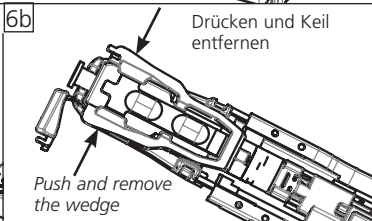

Push and remove the wedge

7 Klammern 1 und 3 öffnen und Stecker aus Steckerhalter entfernen

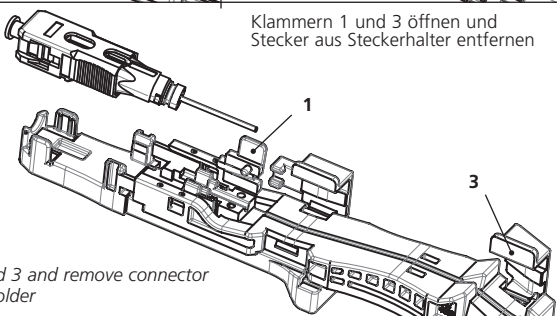

Open covers 1 and 3 and remove connector from connector holder

8 Überprüfung der Verbindung mittels / Checking of connection with visual fault locator

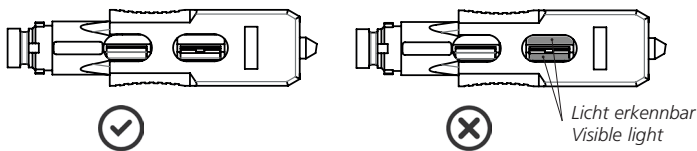

Erfolgreiche Verbindung / Good connection

Schlechte Verbindung / Bad connection

9 Aufteilen der Kevlarfäden, sodass sich das Kevlar jeweils nahe am Stecker befindet

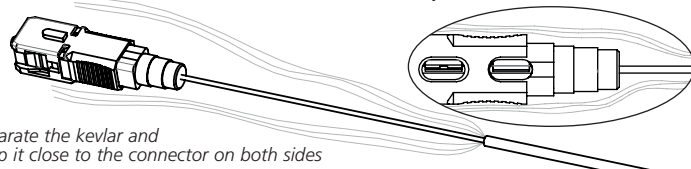

Separate the kevlar and keep it close to the connector on both sides

10 Pre-kevlar-Stopper und Schlauchende nahe an den Stecker führen

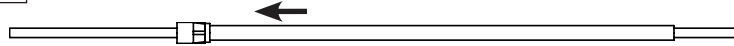

Slowly move pre-kevlar stopper and tube end close to connector

11 Pre-kevlar-Stopper auf das Ende des Steckers clipsen

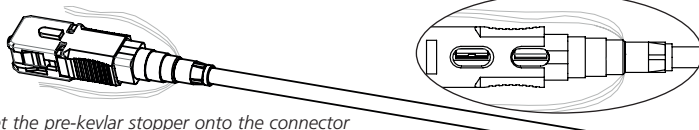

Set the pre-kevlar stopper onto the connector

12 Vollständiges Aufschrauben des Kevlar-Stoppers auf den Stecker ...



Screw the kevlar stopper until it is tightened completely ...

13 ... sodass kein Spalt bleibt / ... so there is no gap left

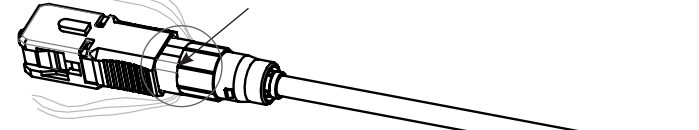

14 Knickschutztülle überziehen / Connect the cable boot

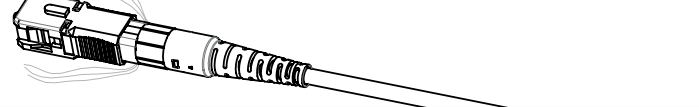

15 Abschneiden der Kevlar-Fäden mittels Kevlarschere

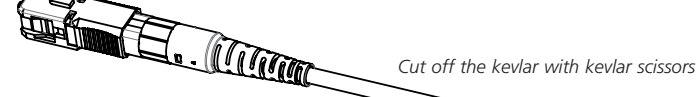

Cut off the kevlar with kevlar scissors