

## Montageanleitung

Ⓒ mounting instruction Ⓕ Notice de montage Ⓒ Instrukcja montażu  
Ⓔ Instrucciones de montaje Ⓘ Istruzioni di montaggio

### EL - A...MRM

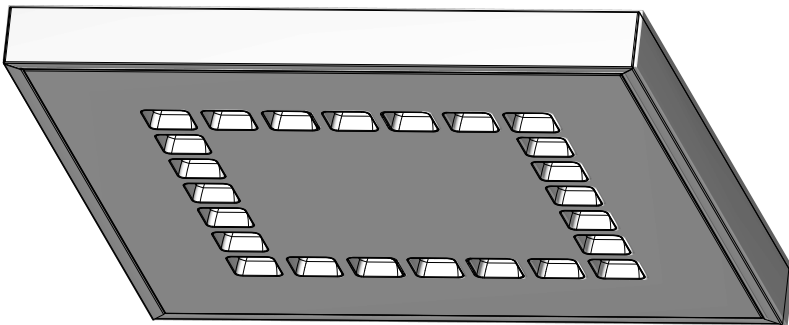

RIDI Leuchten GmbH  
Hauptstrasse 31 - 33 · D-72417 Jungingen  
Tel. 07477/872-0 · Fax 07477/872-48  
kontakt@ridi-group.de · www.ridi-group.com



- (D) Für die Installation und für den Betrieb der Leuchten sind die nationalen Sicherheitsvorschriften zu beachten.
- (GB) Please note national safety instructions for installation and operation of this luminaire.
- (F) Pour l'installation et le fonctionnement des luminaires il est impératif de respecter les normes nationales de sécurité en vigueur.
- (PL) W celu prawidłowej instalacji i poprawnego działania oprawy należy przestrzegać krajowych przepisów bezpieczeństwa.
- (E) Para la instalación y la puesta en funcionamiento de las luminarias deben observarse las normas nacionales de seguridad.
- (I) Per l'installazione e il funzionamento delle lampade si fa riferimento alle normative di sicurezza nazionali.



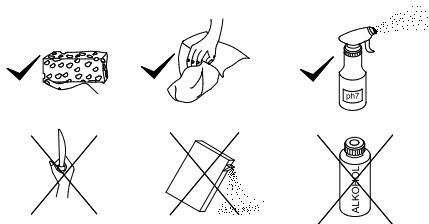
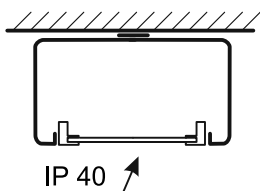





- (D) Die Lichtquelle dieser Leuchte darf nur vom Hersteller oder einem von ihm beauftragten Servicetechniker oder einer vergleichbar qualifizierten Person ersetzt werden.
- (GB) Only the manufacturer, a trained service technician or another equally qualified person is permitted to replace the light source of this luminaire.
- (F) La source lumineuse de ce luminaire ne peut être remplacée que par le fabricant, un technicien de service mandaté par celui-ci ou une personne présentant une qualification analogue.
- (PL) Wymiany źródła światła w tej oprawie oświetleniowej może dokonać wyłącznie producent bądź uprawniony pracownik serwisu albo osoba o podobnych kwalifikacjach.
- (E) La fuente de luz de esta luminaria solamente podrá ser sustituida por el fabricante o una persona designada por este, ya sea un técnico de servicio u otra persona debidamente cualificada.
- (I) La sorgente luminosa di tale lampada può essere sostituita solo dal produttore o da un tecnico di assistenza da questi designato oppure da personale dotato di qualifica equivalente.













Druckfehler und Irrtum vorbehalten.  
Formelle und technische Änderungen behalten wir uns vor.

Misprints and errors excepted.  
We reserve the right of formal and technical modifications.









EL - AN...MRM

Typ	L	B	A1	A2	K	K1	K2	K(EDS)			4/16
0597...	605	123	300	--	L/2	480	26,5	44	120		
1197...	1205		900		L/2	1080			220		
1497...	1505		1200		L/2	1380			265		
0622...	630		300		L/2	480			125		
1247...	1255		900		L/2	1080			180		
1547...	1555		1200		L/2	1380			270		







EL - AS...MRM

Typ	L	B	A1	A2	K	K1	K2	K(EDS)			4/16
0310...	318	191	150	--	L/2	--	--	44	140		
0483...	491		285						140		
0597...	605	187	325			103,5	65		145		
0622...	630		325						150		
1197...	1205		900						490	260	
1247...	1255		950			270					
1497...	1505		1200			640			320		
1547...	1555		1250						330		

EL - AE...MRM

Typ	L	B	A1	A2	K	K1	K2	K(EDS)			5/16
0597...	605	301	400	132	L/2	194	--	44	195		
1197...	1205		900	132 / B/2	--	22		22	210		
1497...	1505		1200	132 / B/2	L/2	--		44	365		
0622...	630	314	400	132	L/2	194		44	400		
1247...	1255		950	132 / B/2	--	22		22	460		
1547...	1555		1250	132 / B/2	L/2	--		44	485		

EL - AQ...MRM

Typ	L	B	A1	A2	K	K1	K2	K(EDS)			6/16
0310...	318	318	150	--	L/2	--	--	44	115		
0483...	491	491	285	149					74,5	215	
0597...	605	601	400	435		194	--		340		
0622...	630	626							350		

# EL - AN...MRM

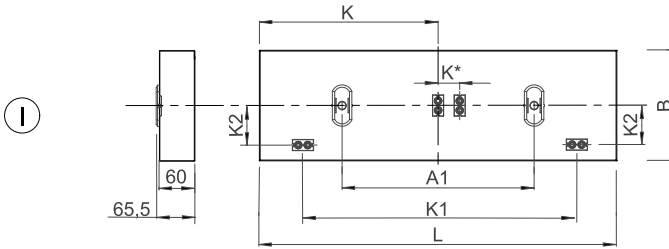

# EL - AS...MRM

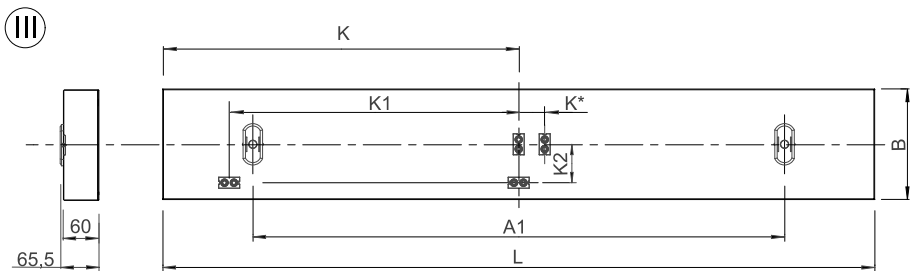
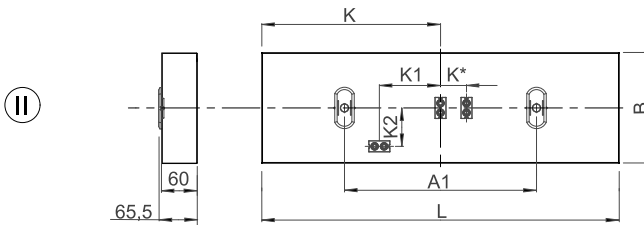

optional

\* EDS



EL - A...MRM... EDS

12/16

# EL - AE...MRM

IV

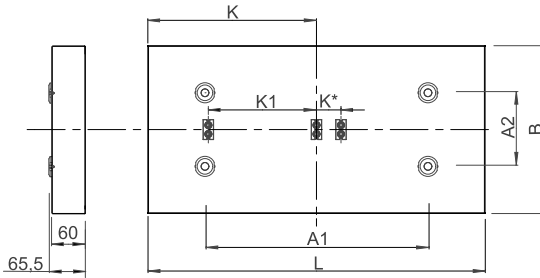

V

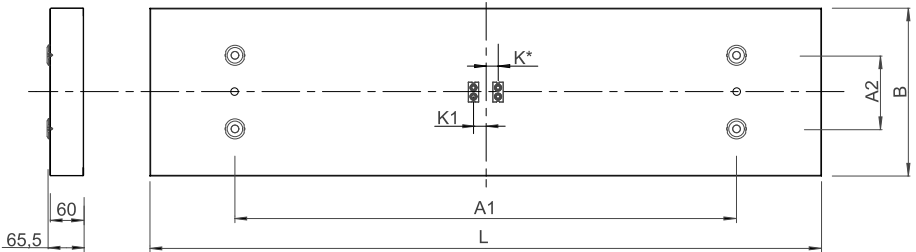

optional

\* EDS



EL - A...MRM... EDS

12/16

# EL - AQ...

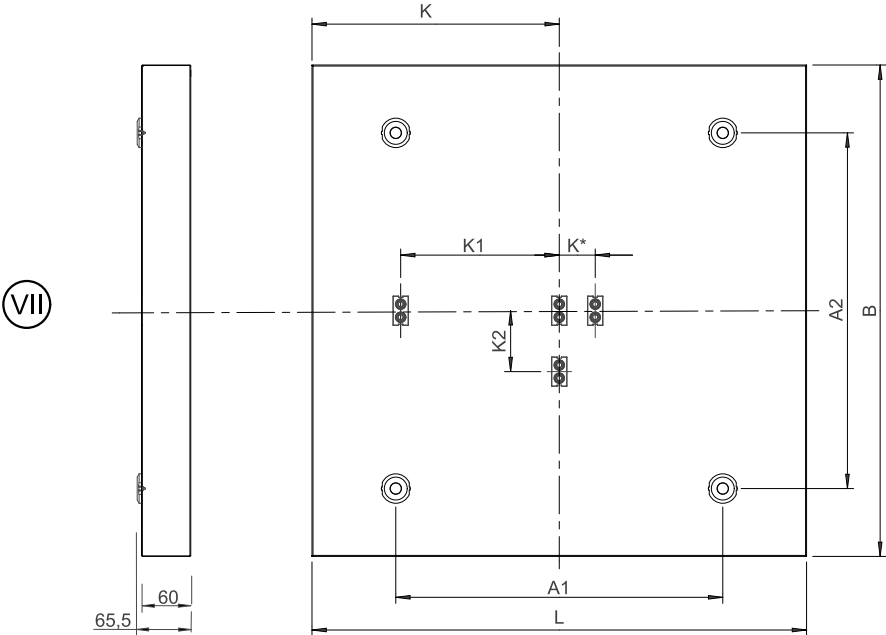
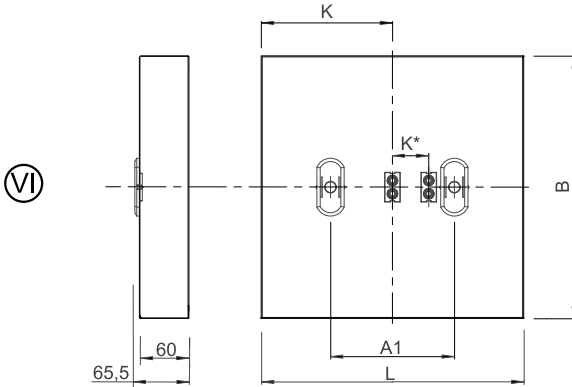

optional

\* EDS

➔ EL - A...MRM... EDS 12/16

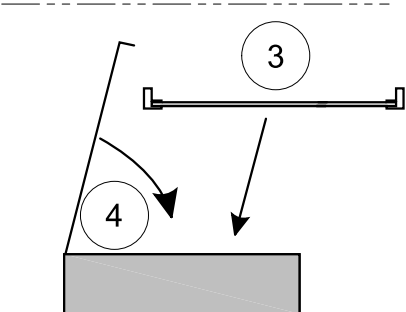
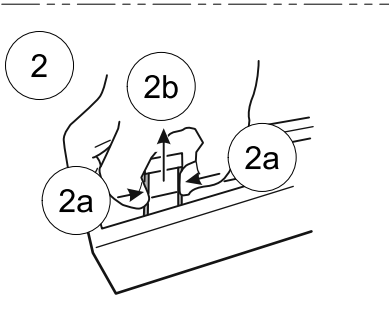
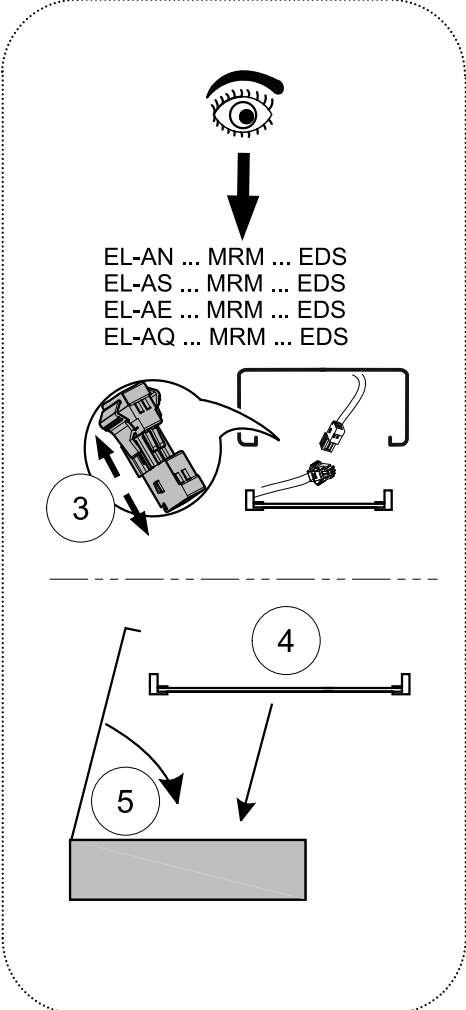
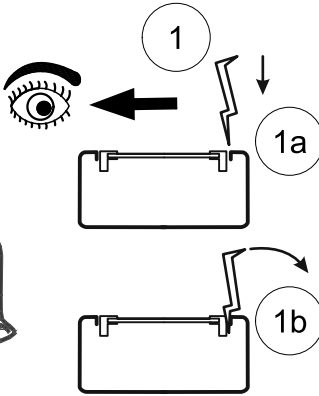
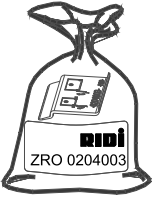
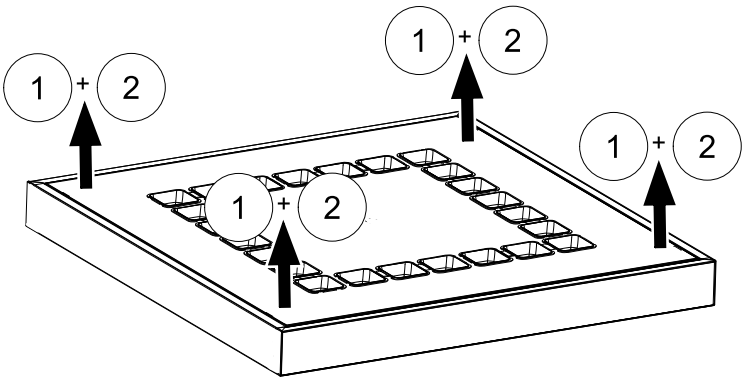

EL - AN...MRM  
 EL - AS...MRM  
 EL - AE...MRM  
 EL - AQ...MRM

bauseits  
 to be supplied on-site  
 À prévoir sur place  
 we własnym zakresie  
 por parte del cliente  
 a cura del cliente

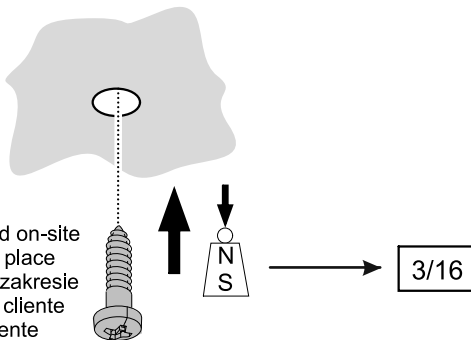

EL - AN...MRM  
 EL - AS...MRM

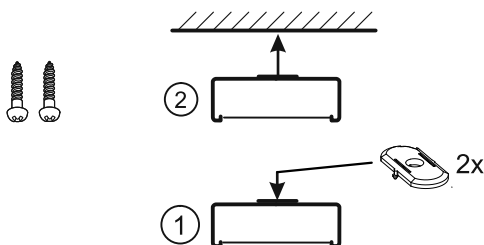

EL - AE...MRM  
 EL - AQ...MRM

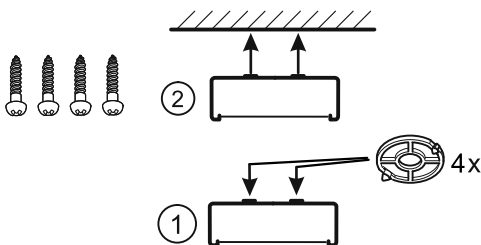

EL - AN...MRM  
 EL - AS...MRM  
 EL - AE...MRM  
 EL - AQ...MRM

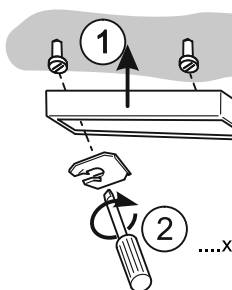



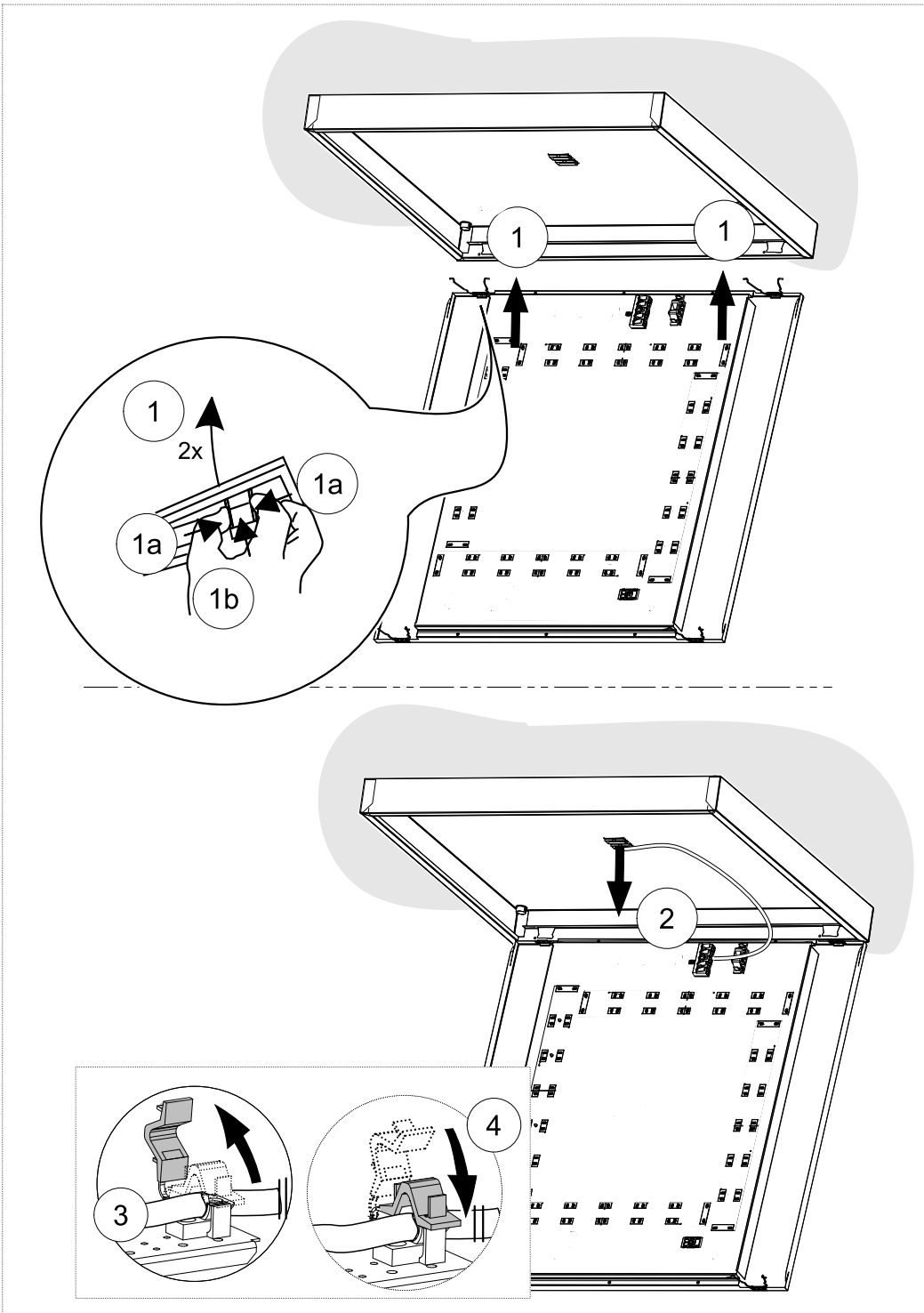

EL - AN...MRM  
 EL - AS...MRM  
 EL - AE...MRM  
 EL - AQ...MRM

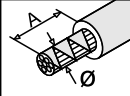
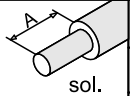
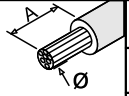
	Ø	A		mm <sup>2</sup>	A		mm <sup>2</sup>	A
	0,8-1,2	9		0,5-1,0	9		0,8-1,2	9
max. Ø1,8mm	1,3-1,8	12	0,5-2,5mm <sup>2</sup>	1,5-2,5	12	max. Ø1,8mm	1,3-1,8	12

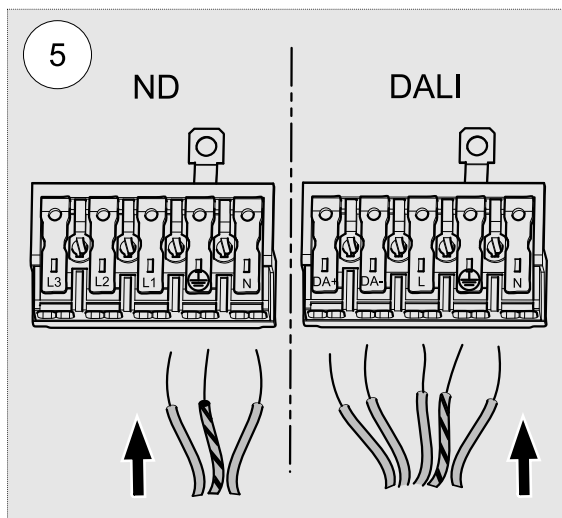

VOLT ?



**RIDI** .....

.....

AC 220-240V/50-60Hz

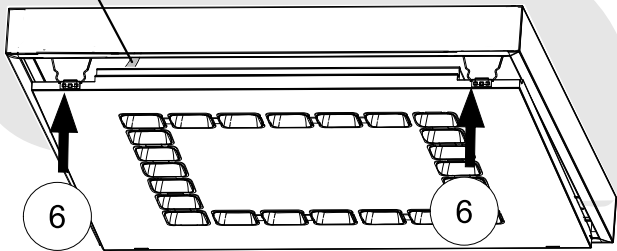
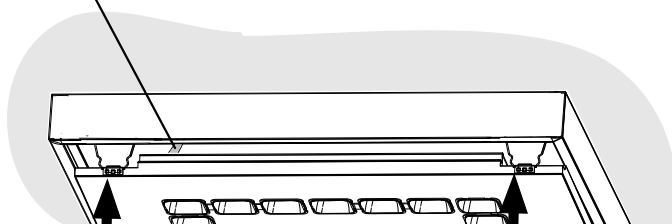
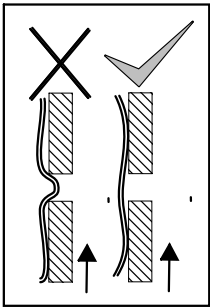
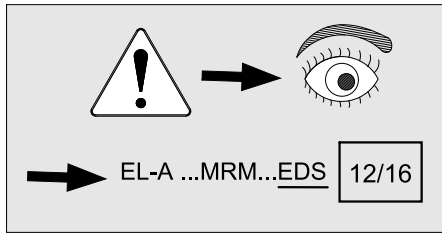

EL-AN...MRM ... EDS  
 EL-AS...MRM ... EDS  
 EL-AE...MRM ... EDS  
 EL-AQ...MRM ... EDS

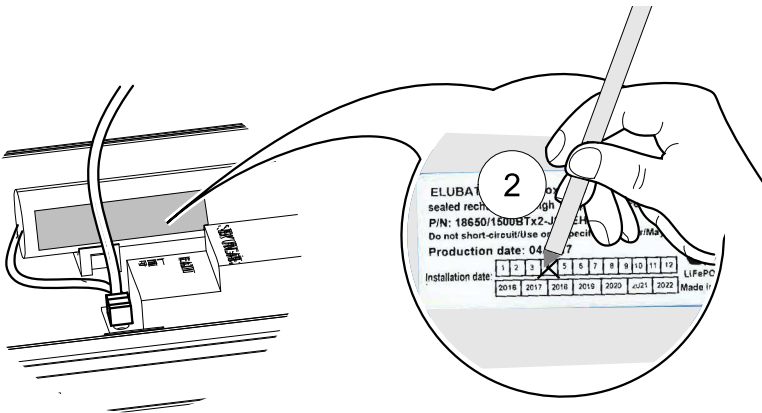
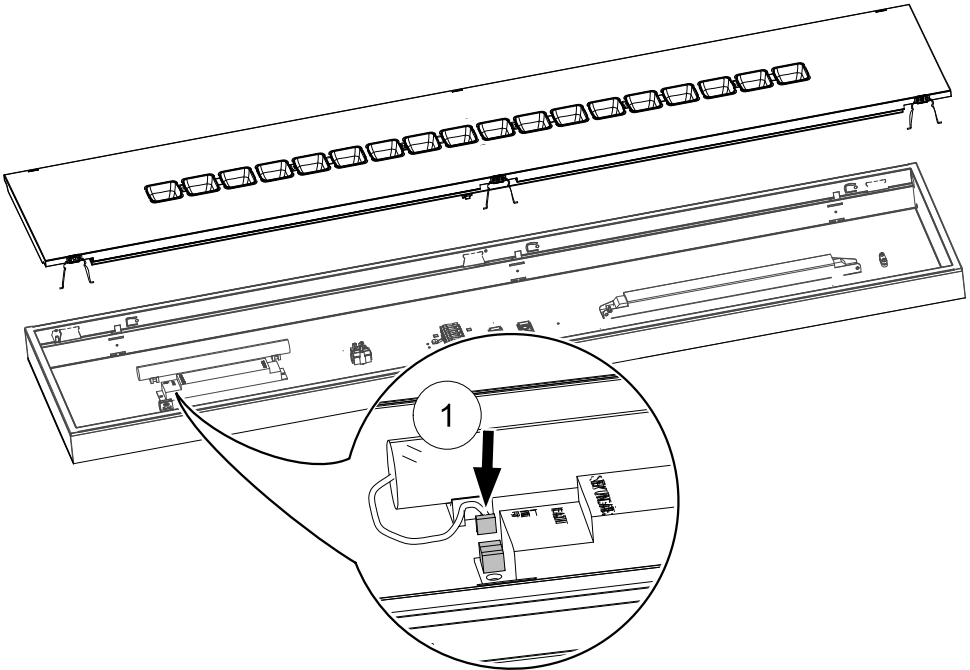

EL-AN...MRM ... EDS  
EL-AS...MRM ... EDS  
EL-AE...MRM ... EDS  
EL-AQ...MRM ... EDS

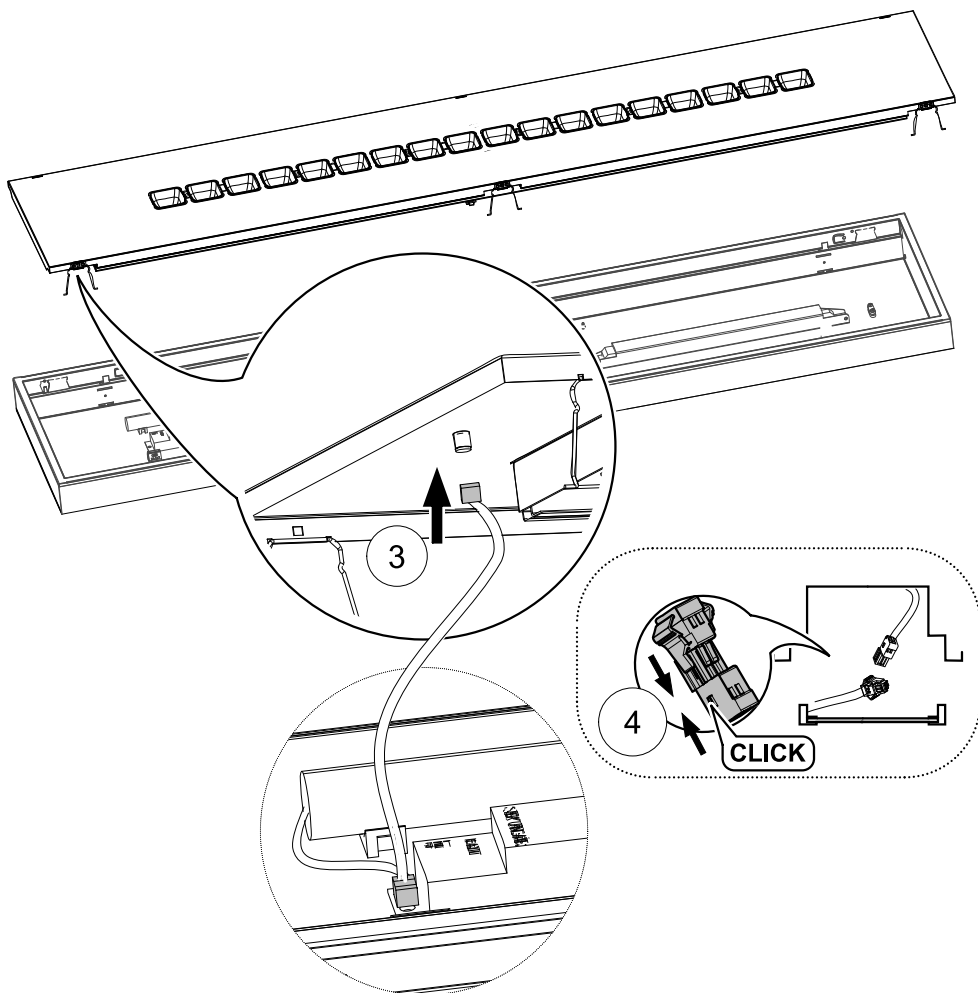

11/16 6

	Ø	A		mm <sup>2</sup>	A		mm <sup>2</sup>	A	
	0,8-1,2	9		sol.	0,5-1,0		9	0,8-1,2	9
	max. ø1,8mm	1,3-1,8		12	0,5-2,5mm <sup>2</sup>		1,5-2,5	12	max. ø1,8mm

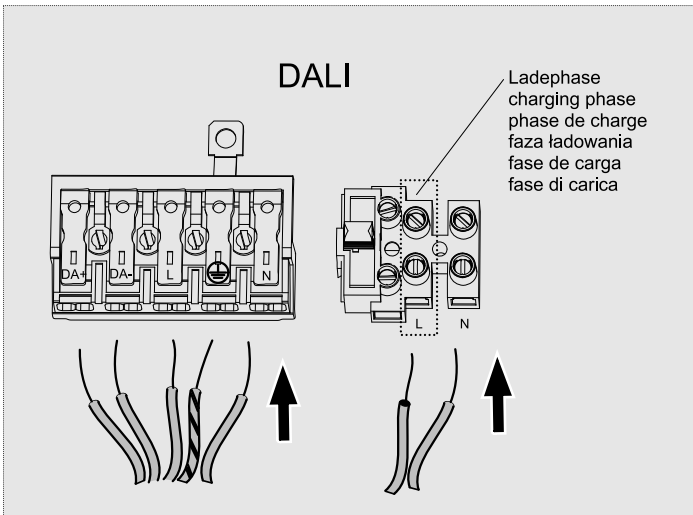
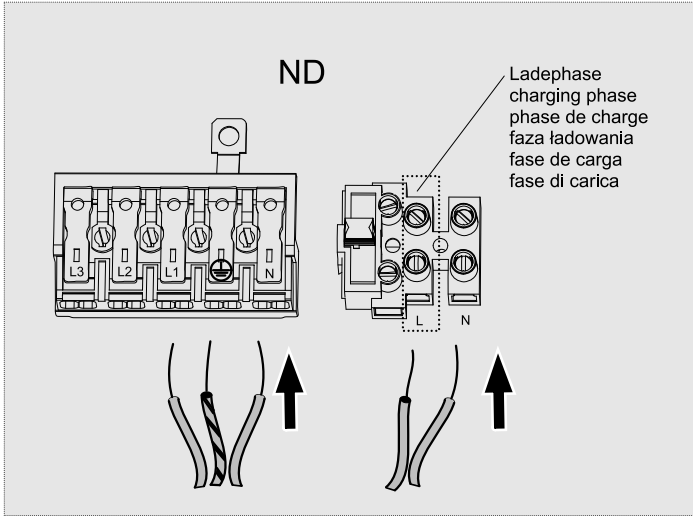



- (D) Austausch nur mit der Original T 2,0A H 250 Sicherung
  - (GB) Warning: Only replace with the original T 2.0A H 250 V fuse
  - (F) Attention, échange seulement avec le fusible original T 2,0A H 250
  - (PL) Uwaga, wymiana tylko na oryginalny bezpiecznik T 2,0 A H 250
  - (E) Atención: cambiar solo por el fusible original T 2,0A H 250
  - (I) Attenzione: cambio solo con il fusibile originale T 2,0A H 250
- 

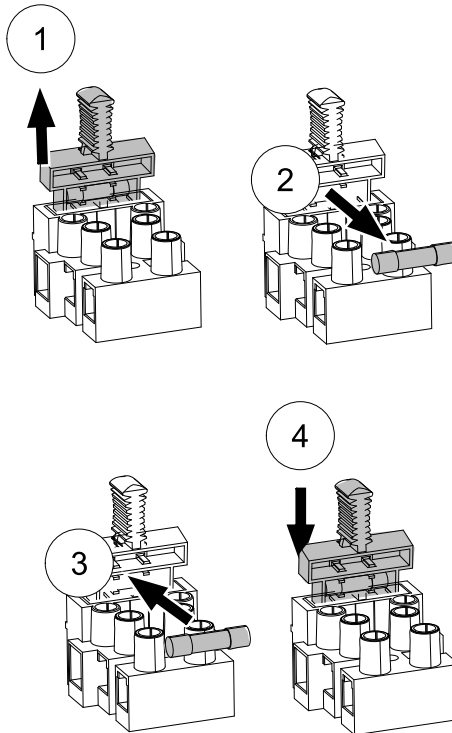

EL - AN ... MRM...SEN  
EL - AS ... MRM...SEN  
EL - AE ... MRM...SEN  
EL - AQ ... MRM...SEN

