

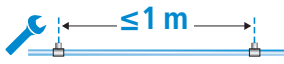

IEC 60417-6182:
Installation,
electrotechnical expertise



IEC 60417-6183:
Installation,
mechanical expertise



| | St/tZn | Al | Cu | StSt | Ti | Sn |
|--------|--------|----|----|------|----|----|
| St/tZn | ✓ | ✓ | ✗ | ✓ | ✓ | ✓ |
| Cu | ✗ | ✗ | ✓ | ✓ | ✗ | ✓ |
| StSt | ✓ | ✓ | ✓ | ✓ | ✓ | ✓ |

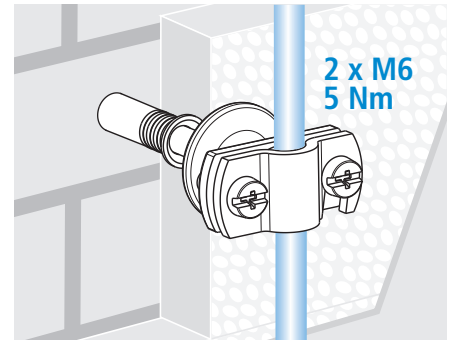
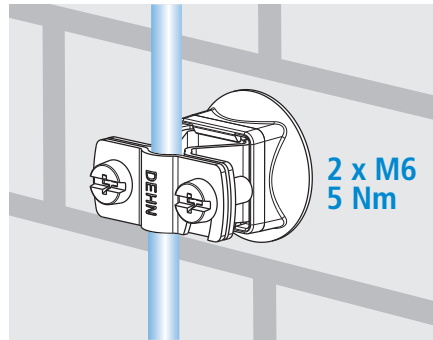
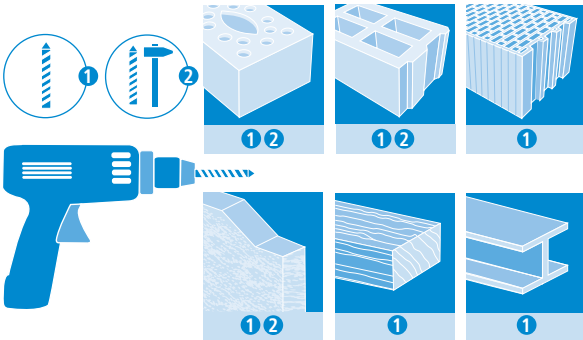
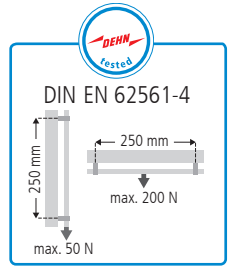

274 110 StSt

274 117 StSt / gal Cu

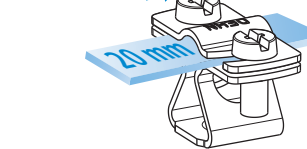
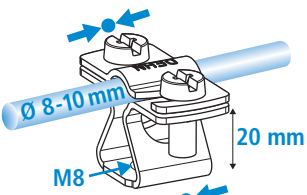

274 160 20 mm StSt

274 167 20 mm StSt / gal Cu

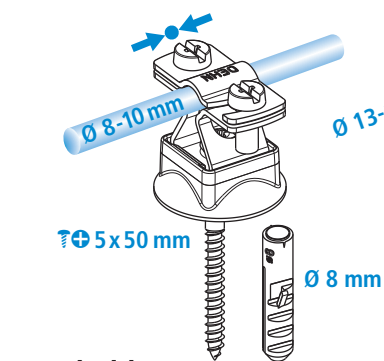

274 150 StSt

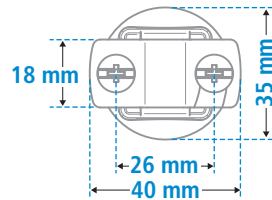
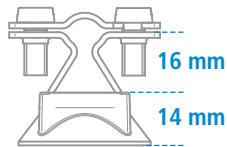
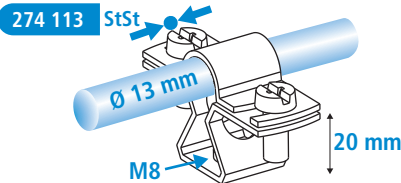
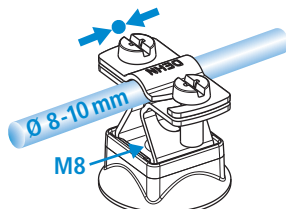

275 110 St/tZn

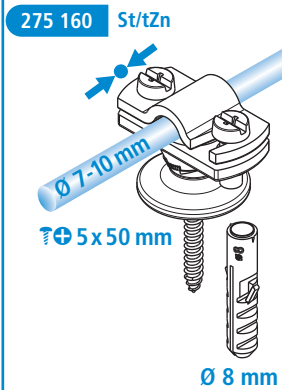
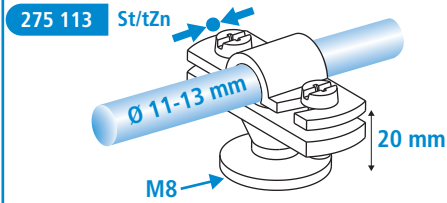
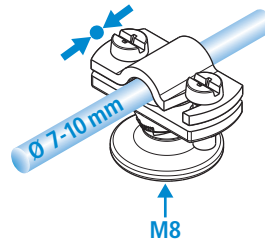

273 740 St/tZn ≍ 140mm

273 741 St/tZn ≍ 180mm

273 742 St/tZn ≍ 240mm

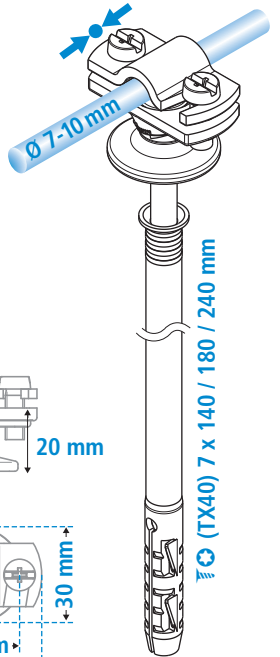

DEHNhold

286 819 StSt

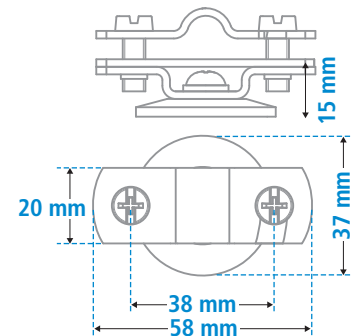
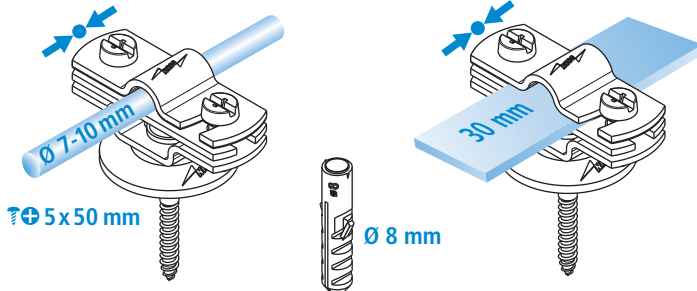

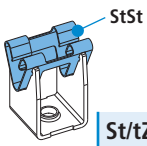
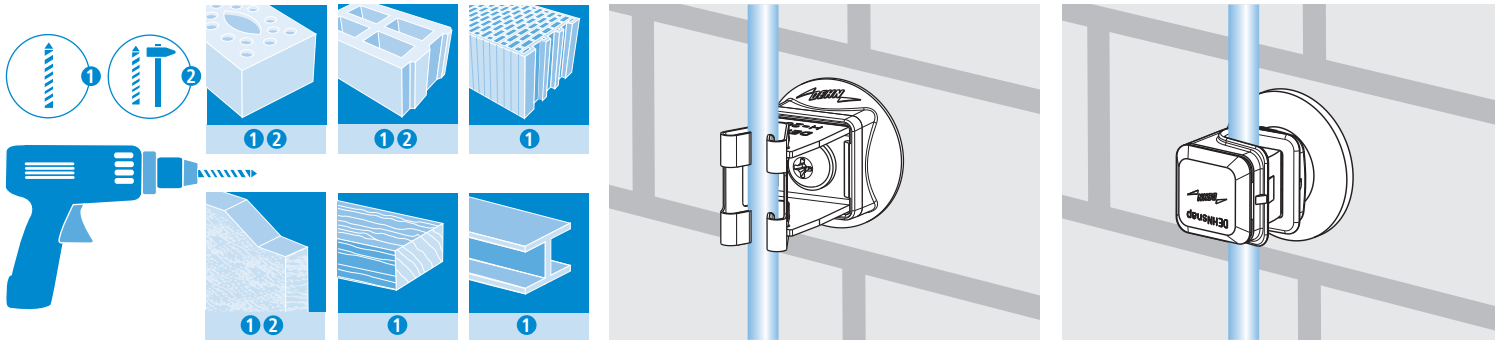
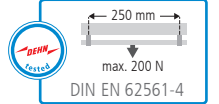

| | St/tZn | Al | Cu | StSt | Ti | Sn |
|------|--------|----|----|------|----|----|
| StSt | ✓ | ✓ | ✓ | ✓ | ✓ | ✓ |

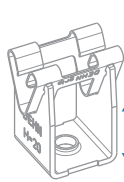

20 mm

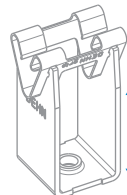

32 mm

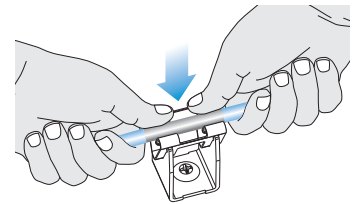

207 019 20 mm StSt

207 009 20 mm StSt

207 109 20 mm StSt

207 039 32 mm StSt

207 029 32 mm StSt

207 017 20 mm Cu

207 007 20 mm Cu

207 107 20 mm Cu

207 037 32 mm Cu

207 027 32 mm Cu

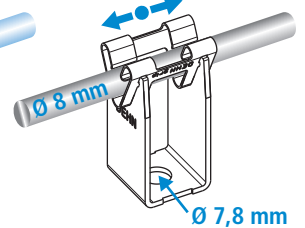
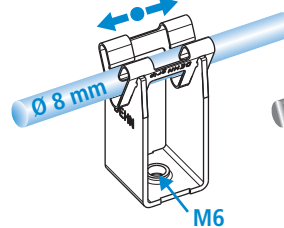
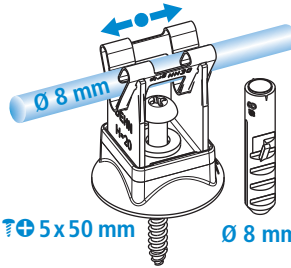
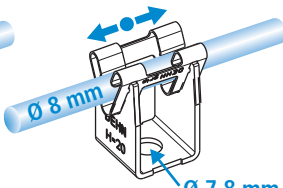
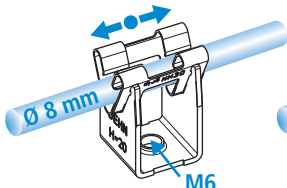

DEHNgrip

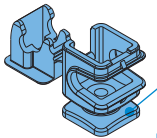

Plastic

| | St/tZn | Al | Cu | StSt | Ti | Sn |
|---------|--------|----|----|------|----|----|
| Plastic | ✓ | ✓ | ✓ | ✓ | ✓ | ✓ |

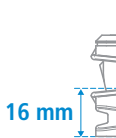

16 mm



36 mm

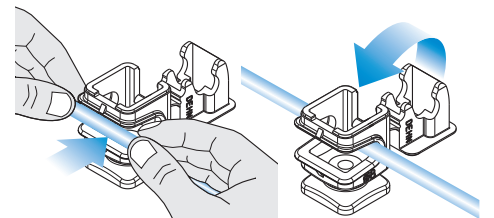

204 001 16 mm / M6

204 002 16 mm / M8

204 006 16 mm

204 120 16 mm

204 003 36 mm / M6

204 004 36 mm / M8

204 007 16 mm / M6

204 017 16 mm / M8

204 027 36 mm / M6

204 037 36 mm / M8

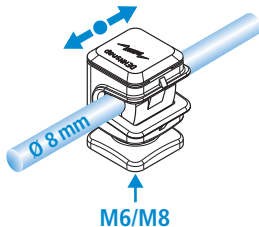

M6/M8

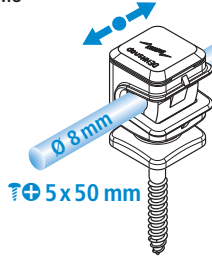

5x50 mm

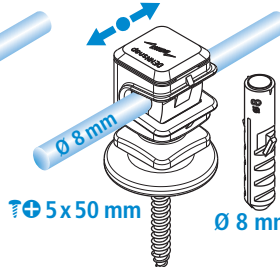

5x50 mm

Ø 8 mm

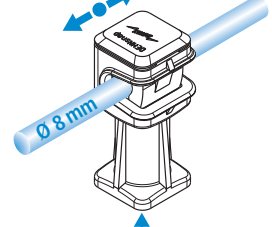

M6/M8

DEHNSnap

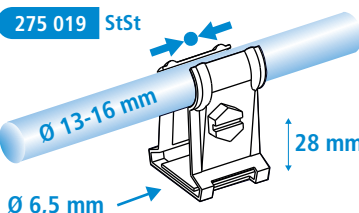

275 019 StSt

Ø 13-16 mm

28 mm

Ø 6,5 mm

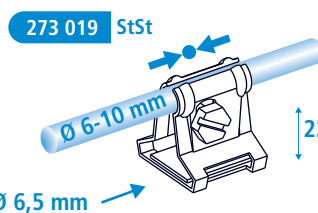

273 019 StSt

Ø 6-10 mm

22 mm

Ø 6,5 mm



DIN EN 62561-4

