

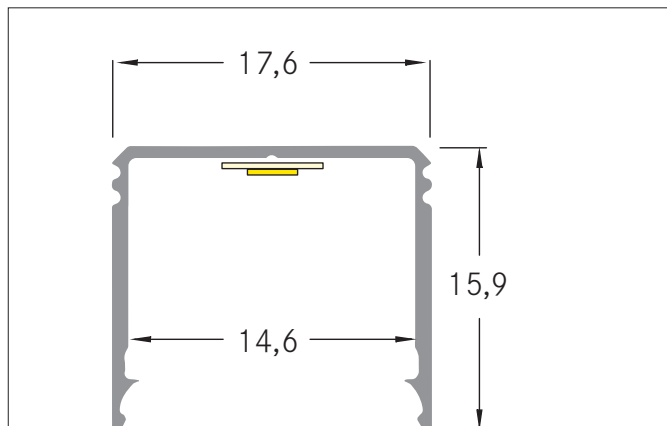

ONE Surface-mounted profile, high

Article no. 53381263

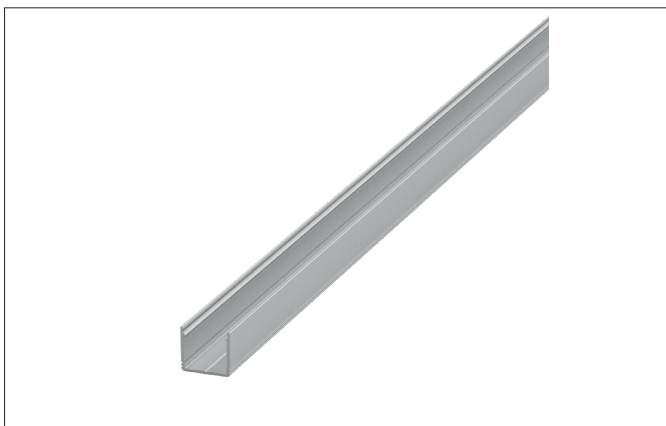

Tender
 Surface-mounted profile, high, aluminum anodized. For optimal attachment of the profile this holders are suitable 53040000. With the use of profile covers 53489071 53489072 53489073 53489001 53489002 53489003 the additional mechanical protection and optimal light distribution can be achieved. The associated end cap set is under 53039260 available. Mounting method: Surface mounting, Material: Aluminium, dimensions profile: length: 3.000 mm x width: 17,6 mm x height: 15,9 mm.

Product Benefits

- High, economical add-on profile.
- Profile and matching covers available in lengths of 1 meter, 2 meters and 3 meters.
- Optimum heat dissipation for long-lasting lighting.

Article data	
Article no.	53381263
GTIN	4251433944843
Series name	ONE
Short description	Surface-mounted profile, high
Material	Aluminium
Colour	aluminum anodized
Length	3,000 mm
Width	17.6 mm
Height	15.9 mm
Weight	0.42 kg
Conformance	CE, UKCA

ONE Surface-mounted profile, high

Article no. 53381263

Packing data	
Gross weight	0.432 kg
Length of packaging	18 mm
Packaging width	16 mm
Packaging height	3,001 mm
Note	Please note that the materials aluminium and PMMA or PC can expand differently with changes in temperature! At a temperature change of 10°C, the coefficient of expansion is approx. aluminium is approx. 0.7mm per metre, for plastic approx. 1.5mm per metre. This is not a defect in the product, this is a normal physical process.
Disposal at end of life	This product must not be disposed of with household waste. You are obliged, to dispose of such electrical waste separately. By disposing of electrical waste and other old or defective electronics separately, you support recycling or other forms of re-use. In that way you help to take care and to avoid that harmful substances get into the environment.