

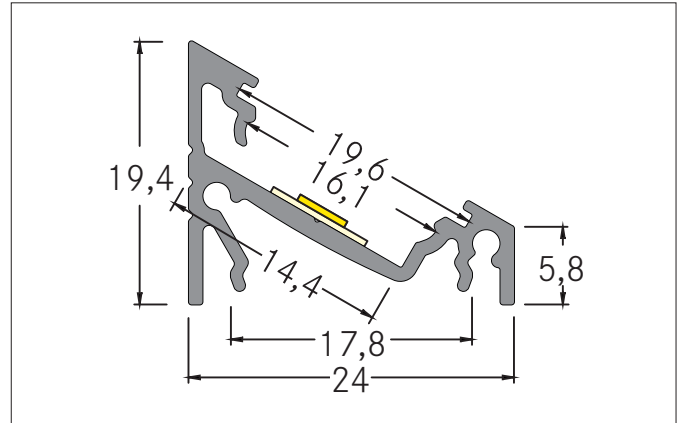

Surface-mounted corner profile complete set 1000 mm

Article no. 53911070

Tender

Surface-mounted corner profile complete set 1000 mm, white. Mounting method: Surface mounting, Material: Aluminium / PMMA / Steel / Plastic, dimensions profile: length: 1.000 mm x width: 24 mm x height: 19,4 mm.

Product Benefits

- One article number for profile, cover and mounting accessories.
- Fast order processing.
- Uncomplicated product selection.
- Matching accessories included in the scope of delivery.

Article data	
Article no.	53911070
GTIN	4251433913382
Short description	Surface-mounted corner profile complete set 1000 mm
Material	Aluminium / PMMA / Steel / Plastic
Colour	white
Transmittance	70 %
Length	1,000 mm
Width	24 mm
Height	19.4 mm
Scope of delivery	1 x Aluminiumprofil Länge 1.000 mm, Farbe: weiß lackiert 2 x Endkappen, Farbe: weiß 2 x Befestigungshalter, Farbe: silber 1 x Abdeckung Länge 1.000 mm, Farbe: opal, Transmissionsgrad: 70% 1 x Schrauben-Set
Weight	0.246 kg
Conformance	CE, UKCA

Surface-mounted corner profile complete set 1000 mm
 Article no. 53911070

Packing data	
Gross weight	0.534 kg
Length of packaging	1,000 mm
Packaging width	30 mm
Packaging height	30 mm
Note	Please note that the materials aluminium and PMMA or PC can expand differently with changes in temperature! At a temperature change of 10°C, the coefficient of expansion is approx. aluminium is approx. 0.7mm per metre, for plastic approx. 1.5mm per metre. This is not a defect in the product, this is a normal physical process.
Disposal at end of life	This product must not be disposed of with household waste. You are obliged, to dispose of such electrical waste separately. By disposing of electrical waste and other old or defective electronics separately, you support recycling or other forms of re-use. In that way you help to take care and to avoid that harmful substances get into the environment.