

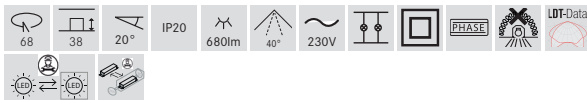
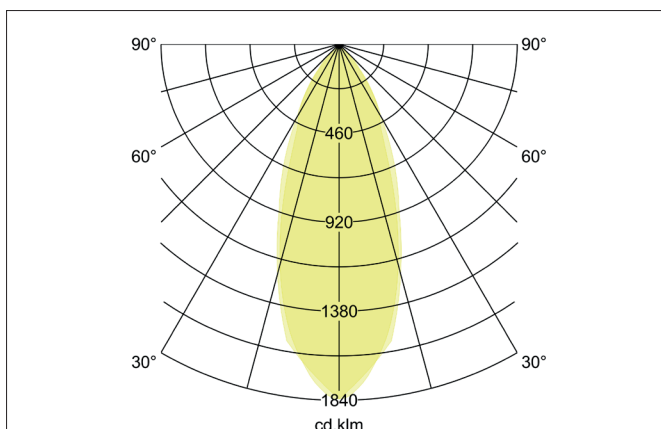
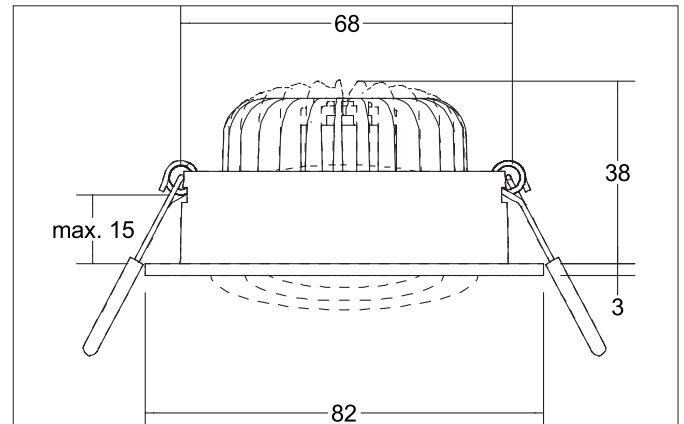

BB34 LED recessed spot set, trailing-edge phase dimmable
 Article no. 39378183

Tender

LED recessed spot set, trailing-edge phase dimmable, Round. Toolless ceiling installation by installation springs. Ceiling cut-out Ø 68 mm, Installation depth 38 mm, Outer diameter 82 mm, Weight 0,208 kg, Reflector silver with rotationssymmetrical, deep, wide distributed light intensity. Cover polycarbonat clear Luminous flux 680 lm, Power 1 x 7 W, Light colour warm white, Correlated color temperature (CCT) 3.000 K, Colour rendering index CRI > 80, Rated life time L70/B50 at 25 °C: 30.000 h, Housing material: Aluminium / Polycarbonate, Colour: black structure, Permissible ambient temperature (ta): -20 °C up to +25 °C, Protection class (EN 61140): II, Degree of protection (DIN EN 60529): IP20. With electronic driver, Trailing-edge phase dimmable.

Product Benefits

- LED recessed spotlight in round design made of solid aluminum with LED module 7 W (3,000 K) and switchable converter.
- Ceiling cut-out 68 mm, diameter 82 mm, installation depth 38 mm, IP20.
- Pivoting range 20°.
- Without visible snap ring.
- Classic, formally restrained design.
- Also available as a dimmable set (trailing edge or DALI) with the same look.
- Also available with the same surface structure and in the same color also available in a square version.

BB34 LED recessed spot set, trailing-edge phase dimmable
 Article no. 39378183

Article data	
Article no.	39378183
GTIN	4251433947998
Series name	BB34
Short description	LED recessed spot set, trailing-edge phase dimmable
Material	Aluminium / Polycarbonate
Colour	black structure
Type of surface	Structure
Shape	Round
Outer diameter	82 mm
Built-in diameter min.	67 mm
Built-in diameter max.	68 mm
Installation depth	38 mm
Hight	3 mm
Weight	0.208 kg
D licence plate	No
Conformance	CE, UKCA

Lighting technology	
Colour temperature	3.000 K
Light colour	white
Light output	Direct
Luminous flux	680 lm
System efficiency	97 lm/W
Colour rendering	CRI > 80
Reflector	Faceted
Reflector colour	silver
Beam angle	40°
Light sharing	Symmetric
Adjustable color temperature	No

Operating technology of the luminaire	
Outer diameter	82 mm
Power	6 W
Voltage type	DC
Current	350 mA
Lamp	LED
Protection class	III
Degree of protection	IP20
Rated life time L70/B50 at 25 °C	30,000 h

Operating technology of driver	
Article No. of used driver	17663010
Length	110 mm
Width	50 mm
Hight	19 mm
AC nominal voltage min	198 V
AC nominal voltage max	264 V
Frequency max	60 Hz
Dimmable	Yes
Control	Trailing-edge phase
Starting current	1 A, 15,2 µs
Power min	2.8 W
Power	7 W
Output current	350 mA
Degree of protection	IP20
Protection class	II
Flicker-free	Yes

BB34 LED recessed spot set, trailing-edge phase dimmable

Article no. 39378183

Mounting technology	
Mounting method	Recessed mounting
Place of installation	Ceiling-mounted
Adjustability	Pivoted
Swivel angle	20°
Max. ceiling thickness	15 mm
Further references	No cover with thermal insulation material
Material cover	Polycarbonat clear
Suitable for through-wiring	Yes, with optional accessories

Packing data	
Gross weight	0.241 kg
Length of packaging	115 mm
Packaging width	86 mm
Packaging height	63 mm
Disposal at end of life	This product must not be disposed of with household waste. You are obliged, to dispose of such electrical waste separately. By disposing of electrical waste and other old or defective electronics separately, you support recycling or other forms of re-use. In that way you help to take care and to avoid that harmful substances get into the environment.

Optional accessories	
Article no.: 81201180 Reducing ring D 110 mm, for luminaire cut-out size 68 mm	Dimensions: 110 mm https://www.brumberg.com/fileadmin/products/Datenblatt_81201180_2021_DE.pdf
Article no.: 81202180 Reducing ring D 130 mm, for luminaire cut-out size 68 mm	Dimensions: 130 mm https://www.brumberg.com/fileadmin/products/Datenblatt_81202180_2021_DE.pdf
Article no.: 81203180 Reducing ring D 145 mm, for luminaire cut-out size 68 mm	Dimensions: 145 mm https://www.brumberg.com/fileadmin/products/Datenblatt_81203180_2021_DE.pdf
Article no.: 83330000 Connection box 230 V AC, 3-pole	Dimensions: 85 mm x 35 mm x 30 mm https://www.brumberg.com/fileadmin/products/Datenblatt_83330000_2021_DE.pdf