

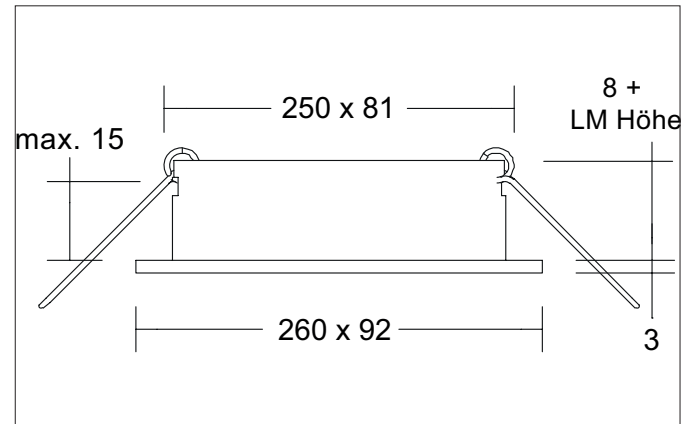

M1 Recessed housing, rectangular, flush, 3-x, with flush module holders, rigid

Article no. 45027180

Tender

Recessed housing, rectangular, flush, 3-x, with flush module holders, rigid, black structure, Square. In a compact design, for installation in tool-less rapid assembly systems. Lamp holder: Without fitting, Mounting method: Recessed mounting, Place of installation: Ceiling-mounted, Material: Aluminium, Degree of protection: according to DIN EN 60529 IP44, Protection class: (EN 61140) III, Power: 13 W, Amount of light sources / fittings: 3 pieces, Adjustability: Not adjustable, without control gear, Dimmable: Depending on type of control gear, Type of dimming: Depending on driver.

Product Benefits

- Part of the modular M1 system for recessed and surface-mounted ceilings.
- Empty housing for accommodating Brumberg LED modules up to a max. output of max. 12.5 W.
- Also available as a similar, rigid housing on the room side in IP44 version.
- Available in single color textured white, textured black or in combination textured white / textured black or textured black / textured white.
- 155 further housing versions plus approx. 30 different LED modules for these housing versions for all common control types.
- Single-lamp versions also in the portfolio.

M1 Recessed housing, rectangular, flush, 3-x, with flush module holders, rigid

Article no. 45027180

Article data	
Article no.	45027180
GTIN	4251433931638
Series name	M1
Short description	Recessed housing, rectangular, flush, 3-x, with flush module holders, rigid
Material	Aluminium
Colour	black structure
Type of surface	Structure
Shape	Square
Length	260 mm
Width	92 mm
Built-in length	250 mm
Built-in width	81 mm
Installation depth	78 mm
Hight	3 mm
Scope of delivery	Incl. module brackets flush, rigid, IP44
Weight	0.407 kg
D licence plate	No
Conformance	CE, UKCA

Operating technology of the luminaire	
Voltage type	DC
Lamp	For LED
Lamp holder	Without fitting
Protection class	III
Protection class on the ceiling side	IP20
Degree of protection	IP44
Dimmable	Depending on type of control gear
Control	Depending on driver
Energy efficiency class	not required

Mounting technology	
Mounting method	Recessed mounting
Place of installation	Ceiling-mounted
Adjustability	Not adjustable
Max. ceiling thickness	15 mm
Further references	No cover with thermal insulation material Smarthome
Cover	Glass transparent
Circlip	Without circlip
Suitable for through-wiring	Yes, with optional accessories

Packing data	
Gross weight	0.468 kg
Length of packaging	261 mm
Packaging width	116 mm
Packaging hight	46 mm
Disposal at end of life	<p>This product must not be disposed of with household waste. You are obliged, to dispose of such electrical waste separately.</p> <p>By disposing of electrical waste and other old or defective electronics separately, you support recycling or other forms of re-use. In that way you help to take care and to avoid that harmful substances get into the environment.</p>

M1 Recessed housing, rectangular, flush, 3-x, with flush module holders, rigid

Article no. 45027180

Compatible LED-modu-							
Article no.	Power	Beam angle	Colour temperature	Colour rendering		Input	Hight LED-Modul
12925003	3 W	38°	2.700 K	CRI > 80		350 mA	40 mm
12926003	3 W	38°	3.000 K	CRI > 80		350 mA	40 mm
12925004	3 W	38°	4.000 K	CRI > 80		350 mA	40 mm
12923383	6 W	38°	2.700 K	CRI > 80		350 mA	32 mm
12923603	6 W	60°	2.700 K	CRI > 80		350 mA	32 mm
12927383	6 W	38°	2.700 K	CRI > 90		350 mA	32 mm
12924383	6 W	38°	3.000 K	CRI > 80		350 mA	32 mm
12924603	6 W	60°	3.000 K	CRI > 80		350 mA	32 mm
12928383	6 W	38°	3.000 K	CRI > 90		350 mA	32 mm
12924384	6 W	38°	3.500 K	CRI > 80		350 mA	32 mm
12924604	6 W	60°	3.500 K	CRI > 80		350 mA	32 mm
12928384	6 W	38°	3.500 K	CRI > 90		350 mA	32 mm
12923384	6 W	38°	4.000 K	CRI > 80		350 mA	32 mm
12923604	6 W	60°	4.000 K	CRI > 80		350 mA	32 mm
12927384	6 W	38°	4.000 K	CRI > 90		350 mA	32 mm
12920183	6 W	18°	3.000 K	CRI > 80		350 mA	31 mm
12920243	6 W	24°	3.000 K	CRI > 80		350 mA	31 mm
12920003	6 W	38°	3.000 K	CRI > 80		350 mA	31 mm
12920603	6 W	60°	3.000 K	CRI > 80		350 mA	31 mm
12920184	6 W	18°	4.000 K	CRI > 80		350 mA	31 mm
12920244	6 W	24°	4.000 K	CRI > 80		350 mA	31 mm
12920004	6 W	38°	4.000 K	CRI > 80		350 mA	31 mm
12920604	6 W	60°	4.000 K	CRI > 80		350 mA	31 mm
12963383	6 W	38°	3.000 K - 1.800 K	CRI > 90		350 mA	32 mm
12963603	6 W	60°	3.000 K - 1.800 K	CRI > 90		350 mA	32 mm
12953003	12 W	38°	2.700 K	CRI > 80		350 mA	70 mm
12954003	12 W	38°	3.000 K	CRI > 80		350 mA	70 mm
12954004	12 W	38°	3.500 K	CRI > 80		350 mA	70 mm
12953004	12 W	38°	4.000 K	CRI > 80		350 mA	70 mm
12965003	12 W	38°	3.000 K - 1.800 K	CRI > 90		350 mA	70 mm
12983003	12.5 W	38°	3.000 K	CRI > 97		350 mA	95 mm
12823003	8 W	60°	2.850 K	CRI > 90		24.00 V	52 mm
12845604	8 W	60°	2.700 K - 6.500 K	CRI > 90		24.00 V	52 mm
18438002	8 W	60°	RGB+WW	CRI > 90		24.00 V	52 mm
12929503	6.3 W	50°	2.700 K / 3.000 K / 4.000 K	CRI > 80		350 mA	34 mm
12930503	5.9 W	50°	2.700 K / 3.000 K / 4.000 K	CRI > 90		350 mA	34 mm
12933553	6 W	55°	2.700 K / 3.000 K / 4.000 K + dim-2warm (3.000 K - 2.200 K)	CRI > 90		350 mA	32 mm

M1 Recessed housing, rectangular, flush, 3-x, with flush module holders, rigid

Article no. 45027180

Required accessories
Article no.: 17665000 LED converter 350 mA, switchable Power: 1 - 3,2 W, Plug&Play Dimensions: 52 mm x 30 mm x 23 mm https://www.brumberg.com/fileadmin/products/Datenblatt_17665000_2021_DE.pdf
Article no.: 17662000 LED converter 350 mA, on/off switchable Power: 1 - 7,2 W, Plug&Play Dimensions: 68 mm x 35 mm x 21 mm https://www.brumberg.com/fileadmin/products/Datenblatt_17662000_2021_DE.pdf
Article no.: 17662020 LED converter 350 mA, on/off switchable Power: 1 - 7,2 W, Plug&Play + Anschlussbox Dimensions: 35 mm x 21 mm https://www.brumberg.com/fileadmin/products/Datenblatt_17662020_2021_DE.pdf
Article no.: 17613000 LED converter 350 mA, on/off switchable Power: 1 - 15 W, Plug&Play Dimensions: 115 mm x 34 mm x 19 mm https://www.brumberg.com/fileadmin/products/Datenblatt_17613000_2021_DE.pdf
Article no.: 17613020 LED converter 350 mA, on/off switchable Power: 1 - 15 W, Plug&Play + Anschlussbox Dimensions: 115 mm x 34 mm x 19 mm https://www.brumberg.com/fileadmin/products/Datenblatt_17613020_2021_DE.pdf
Article no.: 17621000 LED converter 350 mA, on/off switchable Power: 1 - 21 W, Plug&Play Dimensions: 128 mm x 50 mm x 13 mm https://www.brumberg.com/fileadmin/products/Datenblatt_17621000_2021_DE.pdf
Article no.: 17621020 LED converter 350 mA, on/off switchable Power: 1 - 21 W, Plug&Play + Anschlussbox Dimensions: 128 mm x 50 mm x 13 mm https://www.brumberg.com/fileadmin/products/Datenblatt_17621020_2021_DE.pdf
Article no.: 17663000 LED converter 350 mA, trailing-edge phase dimmable Power: 2,8 - 7 W, Plug&Play Dimensions: 110 mm x 50 mm x 19 mm https://www.brumberg.com/fileadmin/products/Datenblatt_17663000_2021_DE.pdf
Article no.: 17663020 LED converter 350 mA, trailing-edge phase dimmable Power: 2,8 - 7 W, Plug&Play + Anschlussbox Dimensions: 110 mm x 50 mm x 19 mm https://www.brumberg.com/fileadmin/products/Datenblatt_17663020_2021_DE.pdf
Article no.: 17664000 LED converter 350 mA, trailing-edge phase dimmable Power: 10,2 - 14 W, Plug&Play Dimensions: 125 mm x 51 mm x 20 mm https://www.brumberg.com/fileadmin/products/Datenblatt_17664000_2021_DE.pdf

M1 Recessed housing, rectangular, flush, 3-x, with flush module holders, rigid

Article no. 45027180

Required accessories
Article no.: 17664020 LED converter 350 mA, trailing-edge phase dimmable Power: 10,2 - 14 W, Plug&Play + Anschlussbox Dimensions: 125 mm x 51 mm x 20 mm https://www.brumberg.com/fileadmin/products/Datenblatt_17664020_2021_DE.pdf
Article no.: 17652000 LED-round converter 350 mA, trailing-edge phase dimmer Power: 4,9 - 7 W, Plug&Play Dimensions: 51 mm x 24 mm https://www.brumberg.com/fileadmin/products/Datenblatt_17652000_2021_DE.pdf
Article no.: 17652020 LED-round converter 350 mA, trailing-edge phase dimmer Power: 4,9 - 7 W, Plug&Play + Anschlussbox Dimensions: 51 mm x 24 mm https://www.brumberg.com/fileadmin/products/Datenblatt_17652020_2021_DE.pdf
Article no.: 17640000 LED converter 350 mA, trailing-edge phase dimmable Power: 4,2 - 10 W, Plug&Play Dimensions: 102 mm x 38 mm x 21 mm https://www.brumberg.com/fileadmin/products/Datenblatt_17640000_2021_DE.pdf
Article no.: 17640020 LED converter 350 mA, trailing-edge phase dimmable Power: 4,2 - 10 W, Plug&Play + Anschlussbox Dimensions: 102 mm x 38 mm x 21 mm https://www.brumberg.com/fileadmin/products/Datenblatt_17640020_2021_DE.pdf
Article no.: 17643000 LED converter 350 mA, trailing-edge phase dimmable Power: 8,8 - 18 W, Plug&Play Dimensions: 110.5 mm x 52 mm x 22 mm https://www.brumberg.com/fileadmin/products/Datenblatt_17643000_2021_DE.pdf
Article no.: 17643020 LED converter 350 mA, trailing-edge phase dimmable Power: 8,8 - 18 W, Plug&Play + Anschlussbox Dimensions: 110.5 mm x 52 mm x 22 mm https://www.brumberg.com/fileadmin/products/Datenblatt_17643020_2021_DE.pdf
Article no.: 17648000 LED converter 350 mA, trailing-edge phase dimmable Power: 0,7 - 17 W, Plug&Play Dimensions: 166 mm x 46 mm x 34 mm https://www.brumberg.com/fileadmin/products/Datenblatt_17648000_2021_DE.pdf
Article no.: 17648020 LED converter 350 mA, trailing-edge phase dimmable Power: 0,7 - 17 W, Plug&Play + Anschlussbox Dimensions: 166 mm x 46 mm x 34 mm https://www.brumberg.com/fileadmin/products/Datenblatt_17648020_2021_DE.pdf
Article no.: 17657000 LED converter 350 mA, 1-10 V dimmable (analog) Power: 5,2 - 18 W, Plug&Play Dimensions: 110 mm x 52 mm x 22 mm https://www.brumberg.com/fileadmin/products/Datenblatt_17657000_2021_DE.pdf

M1 Recessed housing, rectangular, flush, 3-x, with flush module holders, rigid

Article no. 45027180

Required accessories
Article no.: 17684000 LED converter 350 mA, DALI dimmable (digital) Power: 2,8 - 7 W, Plug&Play Dimensions: 130 mm x 42 mm x 22 mm https://www.brumberg.com/fileadmin/products/Datenblatt_17684000_2021_DE.pdf
Article no.: 17684020 LED converter 350 mA, DALI dimmable (digital) Power: 2,8 - 7 W, Plug&Play + Anschlussbox Dimensions: 130 mm x 42 mm x 22 mm https://www.brumberg.com/fileadmin/products/Datenblatt_17684020_2021_DE.pdf
Article no.: 17658000 LED round converter 350 mA, DALI dimmable (digital) Power: 2,1 - 9 W, Plug&Play Dimensions: 56 mm x 25 mm https://www.brumberg.com/fileadmin/products/Datenblatt_17658000_2021_DE.pdf
Article no.: 17658020 LED round converter 350 mA, DALI dimmable (digital) Power: 2,1 - 9 W, Plug&Play + Anschlussbox Dimensions: 56 mm x 25 mm https://www.brumberg.com/fileadmin/products/Datenblatt_17658020_2021_DE.pdf
Article no.: 17683000 LED converter 350 mA, DALI dimmable (digital) Power: 3,5 - 17 W, Plug&Play Dimensions: 110.5 mm x 52 mm x 22 mm https://www.brumberg.com/fileadmin/products/Datenblatt_17683000_2021_DE.pdf
Article no.: 17683020 LED converter 350 mA, DALI dimmable (digital) Power: 3,5 - 17 W, Plug&Play + Anschlussbox Dimensions: 110.5 mm x 52 mm x 22 mm https://www.brumberg.com/fileadmin/products/Datenblatt_17683020_2021_DE.pdf
Article no.: 17682000 LED converter 350 mA, DALI dimmable (digital) Power: 1,8 - 18,5 W, Plug&Play Dimensions: 146.5 mm x 43.5 mm x 22 mm https://www.brumberg.com/fileadmin/products/Datenblatt_17682000_2021_DE.pdf
Article no.: 17682020 LED converter 350 mA, DALI dimmable (digital) Power: 1,8 - 18,5 W, Plug&Play + Anschlussbox Dimensions: 146.5 mm x 43.5 mm x 22 mm https://www.brumberg.com/fileadmin/products/Datenblatt_17682020_2021_DE.pdf
Article no.: 17671000 LED converter 350mA, ZigBee dimmable Power: 3,5 - 18,5 W, Plug&Play Dimensions: 146.5 mm x 44 mm x 30 mm https://www.brumberg.com/fileadmin/products/Datenblatt_17671000_2021_DE.pdf
Article no.: 17671020 LED converter 350mA, ZigBee dimmable Power: 3,5 - 18,5 W, Plug&Play + Anschlussbox Dimensions: 146.5 mm x 44 mm x 30 mm https://www.brumberg.com/fileadmin/products/Datenblatt_17671020_2021_DE.pdf

**M1 Recessed housing, rectangular, flush, 3-x, with flush module holders, rigid**

Article no. 45027180

Required accessories

Article no.: 17672000

LED converter 350mA, Casambi dimmable

Power: 3,5 - 18,5 W, Plug&Play

Dimensions: 146.5 mm x 44 mm x 30 mm

https://www.brumberg.com/fileadmin/products/Datenblatt_17672000_2021_DE.pdf

Article no.: 17672020

LED converter 350mA, Casambi dimmable

Power: 3,5 - 18,5 W, Plug&Play + Anschlussbox

Dimensions: 146.5 mm x 44 mm x 30 mm

https://www.brumberg.com/fileadmin/products/Datenblatt_17672020_2021_DE.pdf**Optional accessories**

Article no.: 3835

Plug&Play extension cable 350 mA

Dimensions: 500 mm

https://www.brumberg.com/fileadmin/products/Datenblatt_00003835_2021_DE.pdf

Article no.: 3836

Plug&Play extension cable 350 mA

Dimensions: 1,000 mm

https://www.brumberg.com/fileadmin/products/Datenblatt_00003836_2021_DE.pdf

Article no.: 3837

Plug&Play extension cable 350 mA

Dimensions: 2,000 mm

https://www.brumberg.com/fileadmin/products/Datenblatt_00003837_2021_DE.pdf